

Data Sheet



Article number: 586350410

Description: Ball Valve 350.410, G 1/2" - G 1/2"
Thread/Thread

Measures

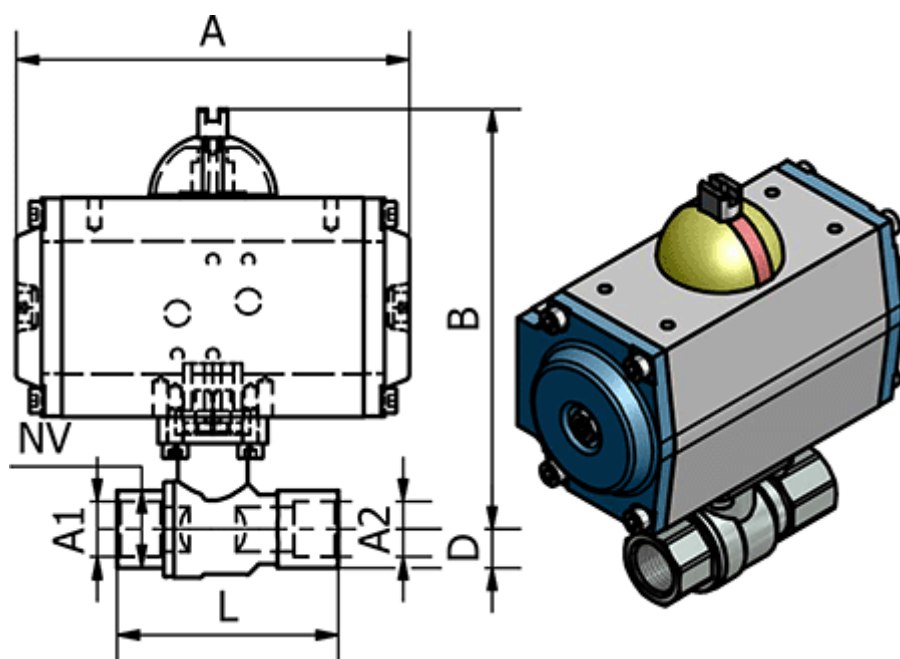

A	= 133
B	= 142
Connecting A1	= G 1/2"
Connecting A2	= G 1/2"
D	= 17
L	= 75
Max. Operating Pressure	= 40 bar
NV	= 26